

710.0445.11

Surface Mounted Drop Seal - 1230-1080mm

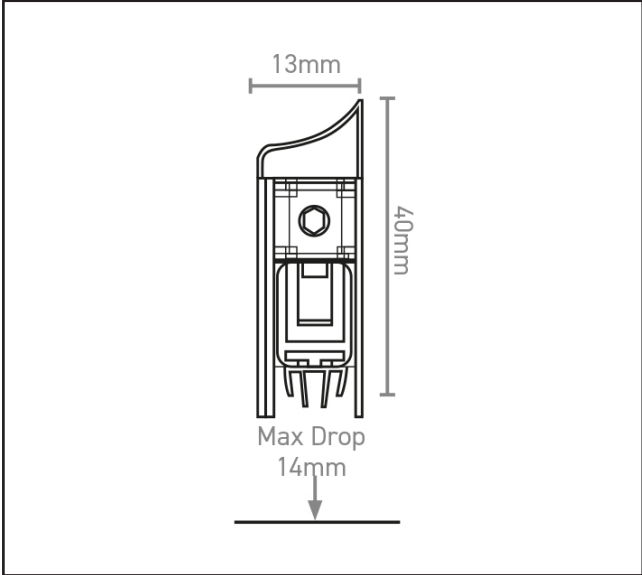

Product Specification

Can be cut down by a maximum of 150mm to 1080mm

Acoustic testing undertaken in accordance with BS EN ISO 140-3:1995 achieving a rating of up to 37dB Rw

Fire tested to BS476: Part 20/22: 1987 to 60 minutes Smoke tested to BS EN 1634-3: 2004

Specification

Colour	Satin Anodised Aluminium
Dimensions	40mm x 13mm
Length	1230mm
Max Cut-Down Amount	150mm
Seal Drop Length	3 - 14mm
Fire Tested	FD30/60

For more information please contact

01451 824110 | sales@wellinguk.com | www.wellinguk.com

Welling Ironmongery Ltd, Unit R1, Bourton Industrial Park, Bourton on the Water GL54 2HQ