

# 120.8105.01

Square Offset Pull Handle – Back to Back

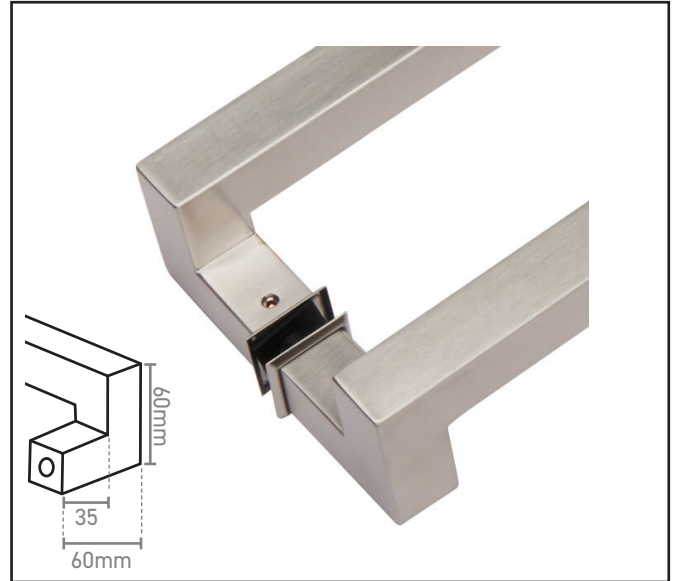

## Product Specification

Back-to-Back - Pair

Suitable for glass or timber doors

Flanges included

## Specification

Finish	Satin Stainless Steel
Length	900mm
Fixing Centres	900mm
Handle Diameter	25mm
Fixing Hole Size	13mm Diameter

For more information please contact

01451 824110 | sales@wellinguk.com | www.wellinguk.com

Welling Ironmongery Ltd, Unit R1, Bourton Industrial Park, Bourton on the Water GL54 2HQ