

610.0077.03

Yale 77 ENB Nightlatch Lock – 60mm Backset

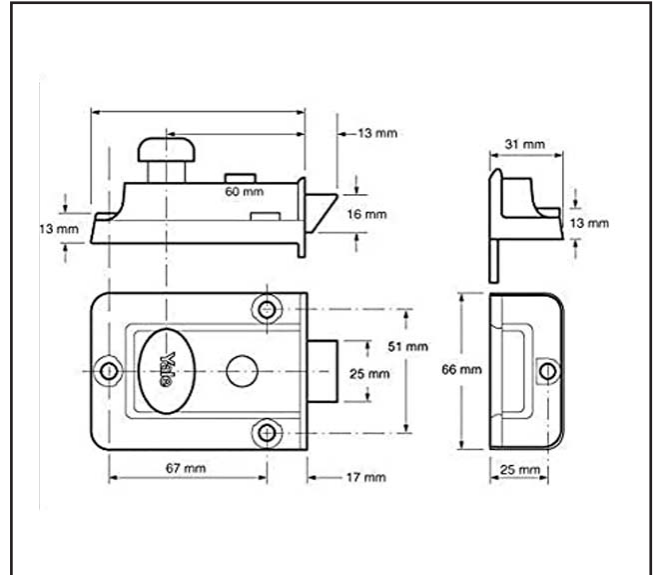

Product Specification

Snib function enables the latch to be held back.

Latch can be deadlocked by the snib button internally.

Suitable for both left and right handed and for inward opening doors up to 57mm thick

Specification

Brand	Yale
Finish	Polished Brass
Backset	60mm
With Keys	Yes, 2nr
Fixings Included	Yes
Door Thickness	54mm
Keying Option	Keyed to Differ

For more information please contact

01451 824110 | sales@wellinguk.com | www.wellinguk.com

Welling Ironmongery Ltd, Unit R1, Bourton Industrial Park, Bourton on the Water GL54 2HQ



Yale® P77 Traditional Nightlatch Fitting Instructions

Tools Required

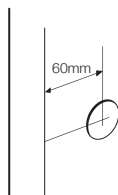

Step 1

1. At the height you want your lock, use a pencil to mark a spot exactly 60mm from the edge of the door. At that spot, drill a 32mm diameter hole through the door.

2. With the key removed, insert the cylinder through the brass ring and place it in the hole.

3. From the back of the door, secure the back plate to the cylinder with the two flat-ended connecting screws supplied, so that it fits flush with the door surface. For doors less than 45mm thick, you will need to shorten the connecting screws to make sure they fit tight on to the back plate.

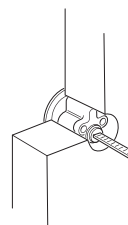

Step 2

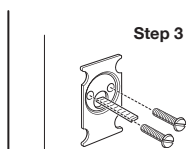

Step 3

4. Place the lock body on the back of the door, making sure that the flat connecting bar of the cylinder is inserted into the slot on the back of the lock body. Mark the outline of the lip of the lock case on the edge of the door and chisel a recess to hold it.

5. Place the lock body on the back of the door in its final position and using a pencil, mark the position of the 3 fixing screws. Then using a 3mm drill bit, drill a 'pilot' hole to a depth of 20mm at each of the three marks. Screw the lock body to the door at those three points using the fixing screws provided.

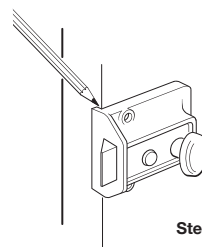

Step 4

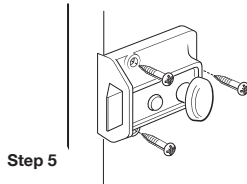

Step 5

6. Gently close the door and using the fitted lock as a guide, mark the position of the remaining component – the 'staple' on the door frame. Chisel out a recess in the door frame to hold the staple flush with the door frame and fix it with the screws provided.

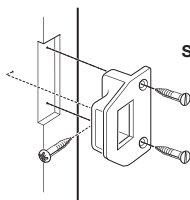

Step 6b

The fitting of your new Yale lock is now complete and guaranteed for 2 years.

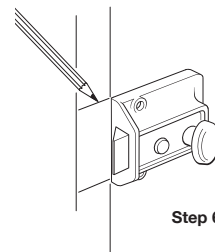

Step 6a

CAUTION:

This lock is not designed for use with outward opening doors.
Do not attempt to modify it.

DOOR THICKNESS: This lock is suitable for doors up to 57mm thick or 54mm where a doorpull is fitted.

CARE OF YOUR CYLINDER RIM LOCK: Never take your cylinder apart. Never oil or paint the cylinder. To lubricate, use a Teflon based solution.

LOCK: Moving parts may be greased.

FOR MAXIMUM SECURITY:

The gap between the lock body and the 'staple' should be kept to a minimum and must never exceed 5mm.



The world's favourite lock since 1843

School Street, Willenhall, West Midlands WV13 3PW
www.yale.co.uk Tel: +44 (0) 1902 364647 E-mail: info@yale.co.uk

Issue No: 01-2012

